

Allura B Extended

LED - Linear Pendant B - Architectural Lighting

Project:	Catalogue #:	Type:
Notes:		

Product Description

Premium-grade, pendant-mount, bi-directional luminaire. The Allura features an architectural slim profile with soft curves to enhance the visual space, and is available with row-mounting capability. This pendant-mount luminaire comes with a double tear drop shaped frosted diffuser that offers a high level of efficiency and visual comfort.

Applications

Boardrooms, Corridors, Retail Stores and Supermarkets, Studio Lofts, Offices



Features

- Double teardrop extruded diffusers
- Standard low voltage dimming (0-10v, 1%)
- Suitable for row-mounting

Featured Options

- Aircraft cable power feed suspension kit
- Emergency lighting battery pack

Optical System

Frosted acrylic diffuser offer high levels of efficiency and visual comfort. The bi-directional optics provide a wide, uniform light distribution. Standard distribution is 25% up and 75% down.

Mounting

Single-point aircraft cable mounting system used at each hanging location.

Construction

Precision-formed steel housing assembly.

Finish

Polyester powder painted finish (textured matte white).

Electrical

Long life LEDs coupled with high efficiency drivers provide quality illumination. Rated to deliver L80 performance >60,000 hours.

Warranty

5 year limited warranty. For complete warranty, click here:



Approvals

- Approved to CSA/UL standards.
- Suitable for damp locations

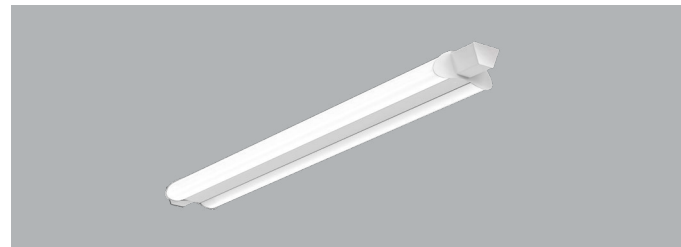

Dimensions

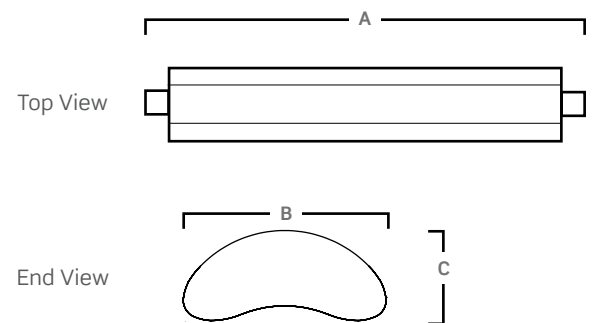

Size	A	B	C
48	51"	6"	2 5/8"
96	95"	6"	2 5/8"

Consult installation guide for exact dimensions.

Project:	Catalogue #:	Type:
Notes:		

Order Key

EXAMPLE: ALRB48-LED840K050LUNV-C91X

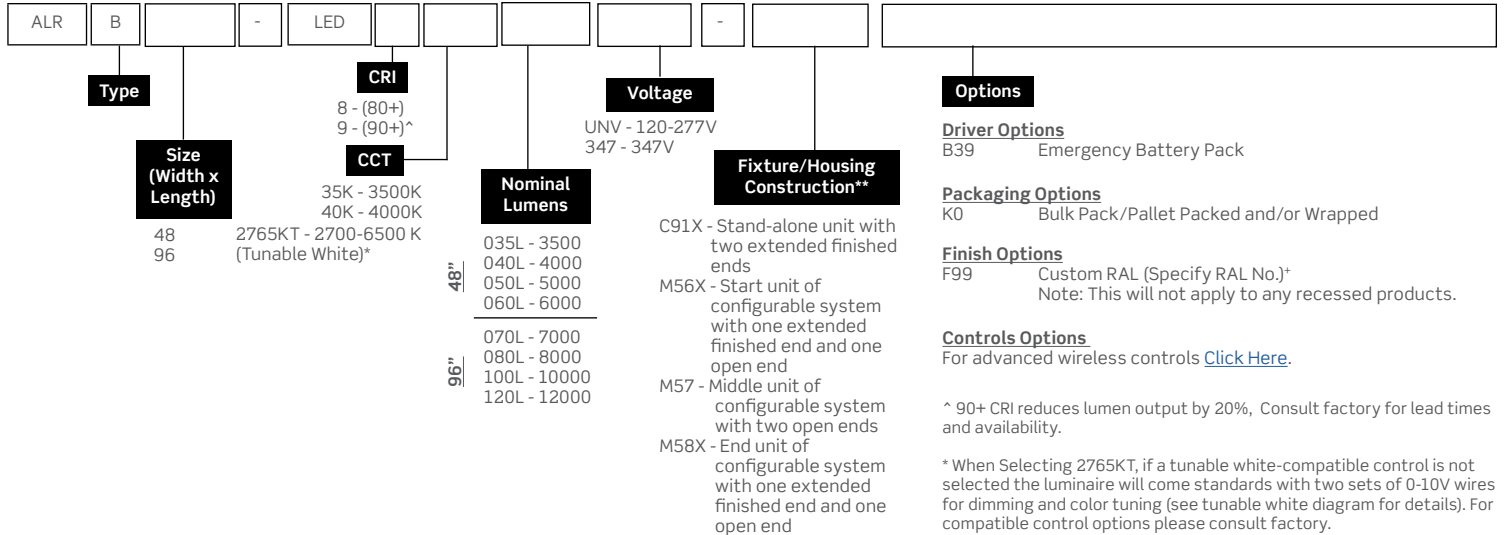

* 90+ CRI reduces lumen output by 20%. Consult factory for lead times and availability.
* When Selecting 2765KT, if a tunable white-compatible control is not selected the luminaire will come standard with two sets of 0-10V wires for dimming and color tuning (see tunable white diagram for details). For compatible control options please consult factory.
**For all stand-alone and configurable units, power feeds, canopies & air craft cables must be ordered separately. See "How to order" section for details.

+Minimum order quantity may apply. Consult factory.

Other options may be available, consult factory. Specifications and data subject to change without notice.

Performance Data

LED Performance Data				
Size	Nominal Lumens	Delivered Lumens	Watts	Lumens Per Watt
48	3500	3525	23.8	148.2
	4000	4020	27.3	147.1
	5000	5031	34.8	144.8
	6000	6024	42.3	142.4
96	7000	7050	47.6	148.2
	8000	8040	54.6	147.1
	10000	10063	69.5	144.8
	12000	12048	84.6	142.4

Values based on 840K with standard lens at 25C

Performance Scaling Factor

	50K	40K	35K	30K
80CRI	1.000	1.000	0.960	0.946
90CRI	0.875	0.875	0.836	0.809

Lifetime Expectancy

	Calculated Hours	Reported Hours
L70	≥238,000	>60,000
L80	≥149,000	>60,000
L90	≥71,000	>60,000

How to Order configurable system

Step 1) Select desired unit from order key above

Part #	Description
C91X	Stand-alone unit
M56X	Start Unit
M57	Middle Unit
M58X	End Unit

Step 2) For configurable system only, select desired connector(s), or stand-alone models, see step 3.

Part #	Description
KIT00171	Straight Connector
KIT00172	Elbow Connector (90 Degrees)
KIT00173	T Connector
KIT00174	Cross Connector

Step 3) Select suspension kit(s) and power feed(s)***

Part#	Description
KIT00188	48" Air Craft Cable & Canopy
KIT00189	5-Wire UNV Power Feed with 48" Air Craft Cable & Canopy
KIT00230 [†]	6-Wire UNV Power Feed with 48" Air Craft Cable & Canopy (Emergency)
KIT00190	3-Wire 347V Power Feed with 48" Air Craft Cable & Canopy (Non-dimmable)
KIT00191	5-Wire 347V Power Feed with 48" Air Craft Cable & Canopy

***One power feed is recommended for every 60 feet based on 6000 lumens unit on 120V 15A current.

***For other suspension kit lengths, please consult factory.

[†] Emergency suspension kit must be connected to the housing containing emergency battery pack.

Project:	Catalogue #:	Type:
Notes:		

Popular Configurations

Stand-alone with flat ends

Part#	Description	Qty.
C91X		1
KIT00188		1
KIT00189		1

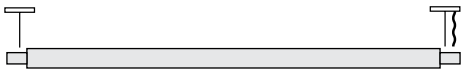

Tee with flat ends

Part#	Description	Qty.
M58X Unit		3
KIT00188		3
KIT00189		1
KIT00173		1

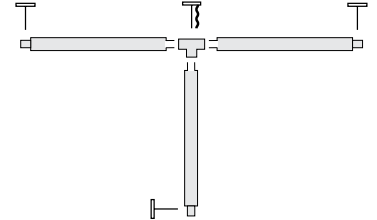

Cross with flat ends

Part#	Description	Qty.
M58X Unit		4
KIT00188		4
KIT00189		1
KIT00174		1

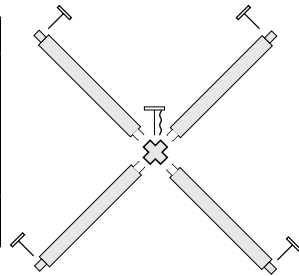

Square / Rectangle

Part#	Description	Qty.
M57 Unit		4
KIT00188		3
KIT00189		1
KIT00172		4

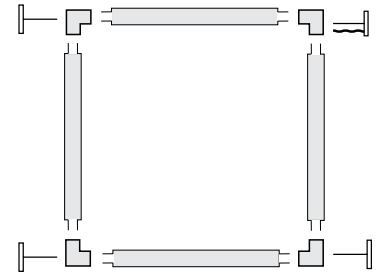

Row with flat ends

Part#	Description	Qty.
M56X Unit		1
M57 Unit		2
M58X Unit		1
KIT00188		4
KIT00189		1
KIT00171		3

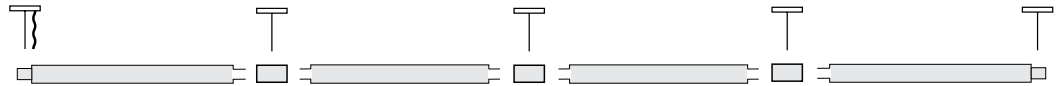

Allura B Extended

LED - Linear Pendant B - Architectural Lighting

Project:	Catalogue #:	Type:
Notes:		

Mounting Points

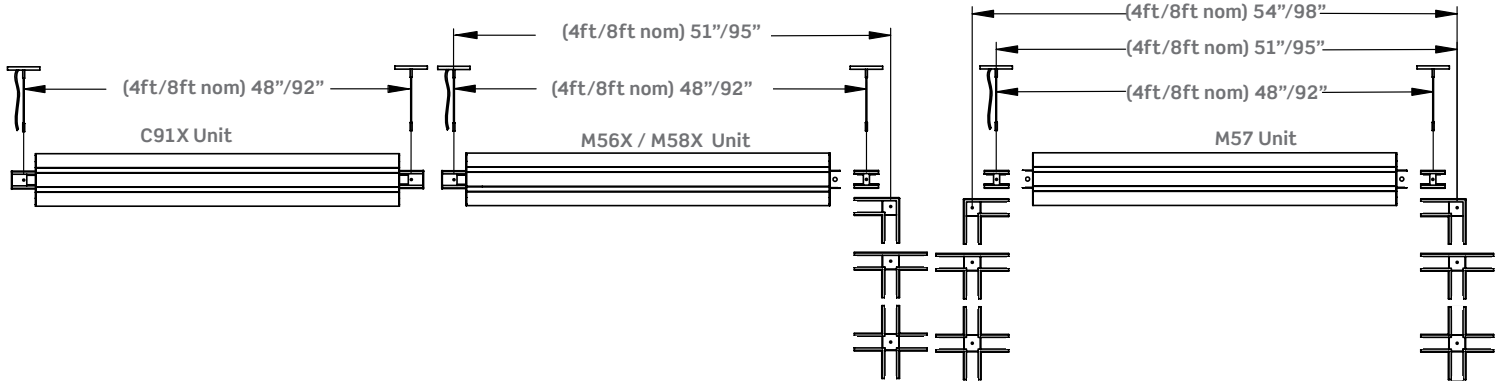

Photometrics

IES File: **ALRB48-LED840K060LUNV**
 Lumens: **6016**
 Wattage: **47**
 Efficacy: **128**

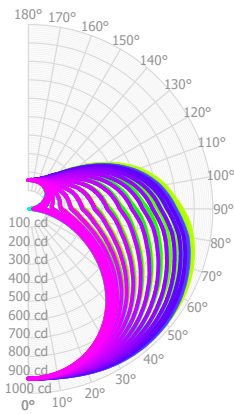

Zonal Lumen Summary

Zone	Lumens	%Fixture
0.0° - 30.0°	755	12.5%
0.0° - 40.0°	1284	21.3%
0.0° - 60.0°	2517	41.8%
0.0° - 90.0°	4191	69.7%
0.0° - 110.0°	5035	83.7%
0.0° - 130.0°	5593	93.0%
0.0° - 150.0°	5877	97.7%
0.0° - 170.0°	6001	99.7%
0.0° - 180.0°	6016	100.0%

Coefficients of Utilization

pc	80%			70%			50%		
	70%	50%	30%	70%	50%	30%	70%	50%	30%
0	112	112	112	106	106	106	94	94	94
1	98	92	87	92	87	82	81	77	73
2	88	78	70	82	74	67	72	65	60
3	79	68	59	74	64	56	65	56	50
4	72	59	50	67	56	47	59	50	42
5	66	52	43	62	50	41	54	44	37
6	61	47	38	57	44	36	49	39	32
7	56	42	33	52	40	32	46	36	29
8	52	38	29	49	36	28	43	32	26
9	48	35	26	45	33	25	40	30	23
10	45	32	24	42	30	23	37	27	21

Average Luminance Table (cd/m2) CP Summary

	0.00°	45.00°	90.00°
0.00°	4875	4875	4875
45.00°	4278	4697	5549
55.00°	3863	4808	6217
65.00°	3325	5070	7217
75.00°	2647	5726	8803
85.00°	1293	7542	11745

Effective Floor Cavity Reflectance: 20%

Tunable White

When Selecting 2765KT, if a tunable white-compatible control is not selected the luminaire will come standard with two sets of 0-10V wires for dimming and color tuning. For compatible control options please consult factory.

Dim and CCT control wire colors are subject to change without notice. All control wires are marked per the parentheses.

