

Project:	Catalogue #:	Type:
Notes:		

### Product Description

Specification-grade, recessed, lay-in T-Bar luminaire featuring a shallow elliptical center lens. For use with indoor applications where high-efficiency, high performance and ease of installation are required. This IC-rated luminaire's low-profile design is ideal for shallow or obstructed plenum applications.

This fixture is equipped with BIOS SkyBlue® circadian LED technology, specifically for increased melanopic lux and circadian stimulus for daytime applications. This luminaire can be configured with either BIOS Static for applications where a constant level SkyBlue® content is desired, or BIOS Dynamic for applications requiring variable SkyBlue® content based on time of day. Provides minimum melanopic (M/P) ratio of >0.7 at 3000K, CRI 80+, R9>90; and cyanosis observation index (COI) less than or equal to 5.4.



### Applications

Office Areas, Retail Stores, Classrooms, Corridors, Hospitals.

### Features

- Ideal for shallow or obstructed plenum applications
- Enhanced, uniform lighting delivers a balanced amount of light to walls, cubicles, work surfaces and people
- Extruded acrylic diffuser
- Standard low voltage dimming (0-10v, 1%)
- 80+ CRI
- Available in 1x4, 2x2, 2x4 configurations
- For use in insulated ceilings
- Room side access for driver compartment

### Featured Options

- Emergency lighting battery pack
- Air handling
- Optional lenses, see ordering key

### Optical System

Frosted ribbed linear extruded acrylic diffuser offers high levels of efficiency and visual comfort. Indirect reflectors are precision formed and contoured to provide soft, low-glare, indirect illumination, while maintaining high-efficiency and a wide, uniform light distribution.

### Mounting

This luminaire has been specifically designed for T-Bar applications. Holes provided for chain-mounting support to building structure with integral earthquake clips.

### Construction

Die-formed and riveted, heavy-gauge steel housing assembly. Precision-formed steel reflector. Wiring access plate and knockouts are provided on back of housing.

### Finish

White, polyester powder painted housing.

### Electrical

Long life LEDs coupled with high efficiency drivers provide quality illumination. Rated to deliver L80 performance > 50,000 hours.

### Warranty

5 year limited warranty. For complete warranty, click here: [5YR Warranty](#)

### Approvals

- Approved to CSA/UL standards. UL listed for insulated ceilings.
- Tested in accordance to IESNA LM-79.
- Suitable for damp locations.



### Dimensions

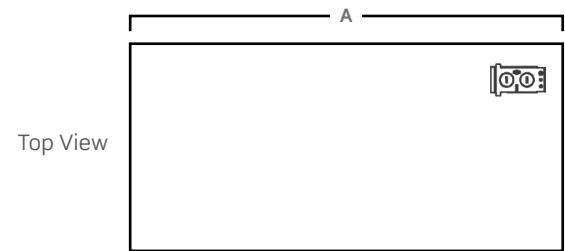

Top View

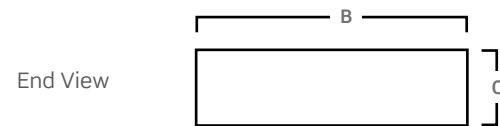

End View

Size	A	B	C
1x4	47 3/4"	11 3/4"	2 1/2"
2x2	23 3/4"	23 3/4"	2 1/2"
2x4	47 3/4"	23 3/4"	2 1/2"

Consult installation guide for exact dimensions.

Project:	Catalogue #:	Type:
Notes:		

### Order Key

#### EXAMPLE: LRTF2x4-LED840K070LUNV-V114(BI01)

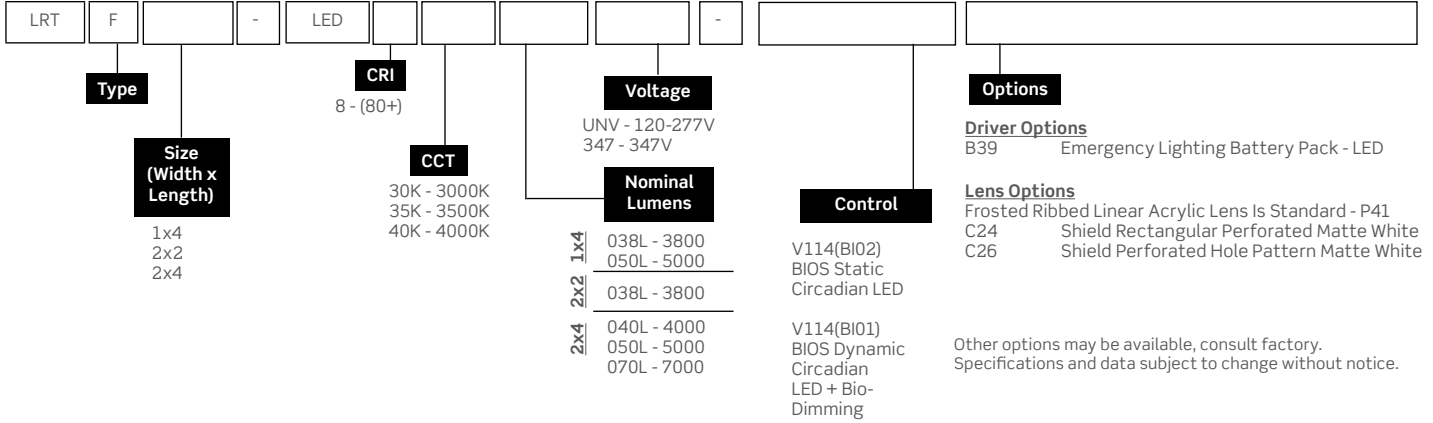

V114(BI03)  
BIOS Dynamic Tunable Circadian LED (tunable to 2700K)

Flange Kits for hard ceiling installation (Ordered Separately)	
Size (Width x Length)	Item No.
1x4	KIT00136
2x2	KIT00137
2x4	KIT00138

### Performance Data

LED Performance Data				
Size	Nominal Lumens	Delivered Lumens	Watts	Lumens per Watt
1x4	3800	3824	24	159.1
	5000	5031	32.2	156.4
2x2	3800	3828	26.5	144.7
2x4	4000	4033	26.1	154.8
	5000	5025	32.9	152.5
	7000	7028	47.6	147.7

### Ordering Key Example

LRTF2x2-LED840K038LUNV-V114(BI02)	<ul style="list-style-type: none"> <li>Static CCT (4000K) fixture, output dimmable to 1%</li> <li>SkyBlue™ is always present</li> </ul>
LRTF2x2-LED840K038LUNV-V114(BI03)	<ul style="list-style-type: none"> <li>2-Channel Tunable (4000K - 2700K) fixture dimmable to 1%</li> <li>SkyBlue™ is always present from 4000k-3000k</li> </ul>
LRTF2x2-LED840K038LUNV-V114(BI01)	<ul style="list-style-type: none"> <li>Single-Channel Bio-Dimming from 4000K with SkyBlue™ to &gt;2700K</li> <li>At 2700K, dim total output to 1%</li> <li>At 2700K, SkyBlue™ no longer present</li> </ul>

Project:	Catalogue #:	Type:
Notes:		

**BIOS Static Circadian LED Solution - V114 (BI02)**

BIOS SkyBlue® Spectrum lighting solutions support proper daytime circadian stimulus, communicating directly with human circadian biology through a non-visual photo receptor in the eye.

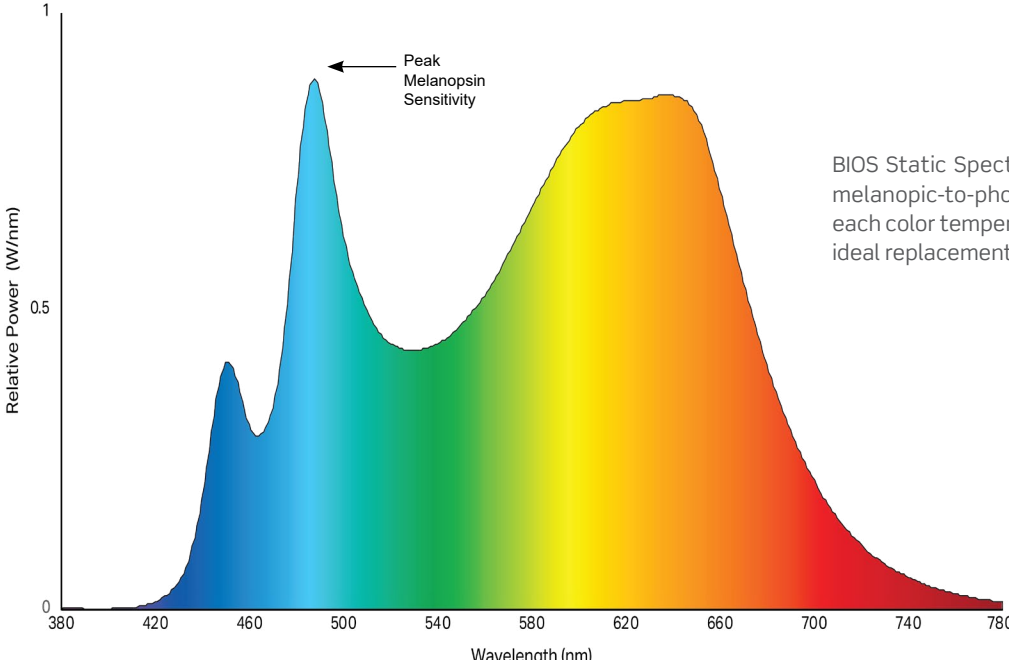

BIOS Static Spectrum Light Engine delivers the industry’s best melanopic-to-photopic (M/P) ratio, with R9 greater than 90 at each color temperature. BIOS Static Spectrum Light Engine is the ideal replacement for static color light fixtures.

Static Engine Spectral Power Distribution (3500K)

**Nominal Performance**

CCT	Melanopic Ratio (M/P) <sup>1</sup>	CRI	R9	COI <sup>2</sup>
3000K	0.74	81	90	5.4
3500K	0.83	84	96	3.3
4000K	0.92	84	95	1.5

<sup>1</sup> M/P is a ratio that describes the relative melanopic lux (M) versus the photopic lux (P)  
<sup>2</sup> COI - Cyanosis Observation Index

Project:	Catalogue #:	Type:
Notes:		

**BIOS Dynamic Circadian LED Solution - V114 (BI01)**

BIOS SkyBlue® Dynamic Light Engine provides full daytime circadian stimulus and can be dynamically adjusted via the Bio-Dimming™ module. Using a standard single channel 0-10V dimmer reducing melanopic lux while keeping light and CCT constant<sup>3</sup>. When the SkyBlue® content has been removed (at 2700K), the light level can be adjusted. The Bio-Dimming™ module also detects the preferred light levels over time and will adjust the high end trim of the system to those preferences.

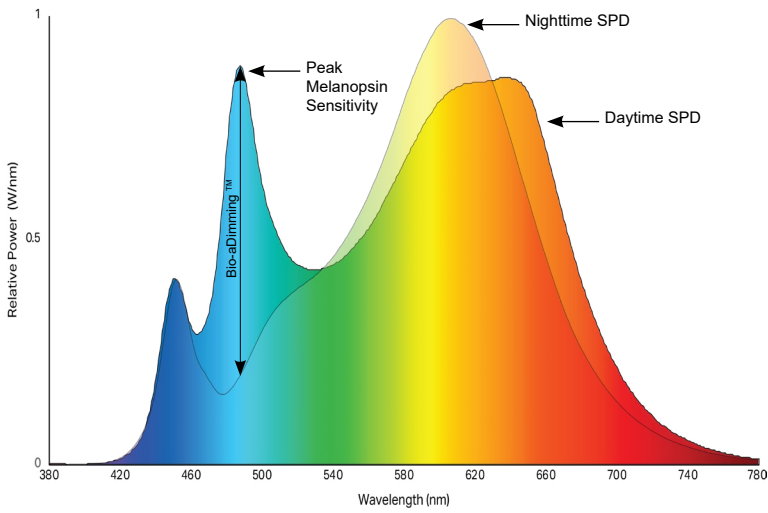

**Dynamic Engine Spectral Power Distribution (3500K)**

**BIOS Dynamic Circadian LED + Bio-Dimming™**

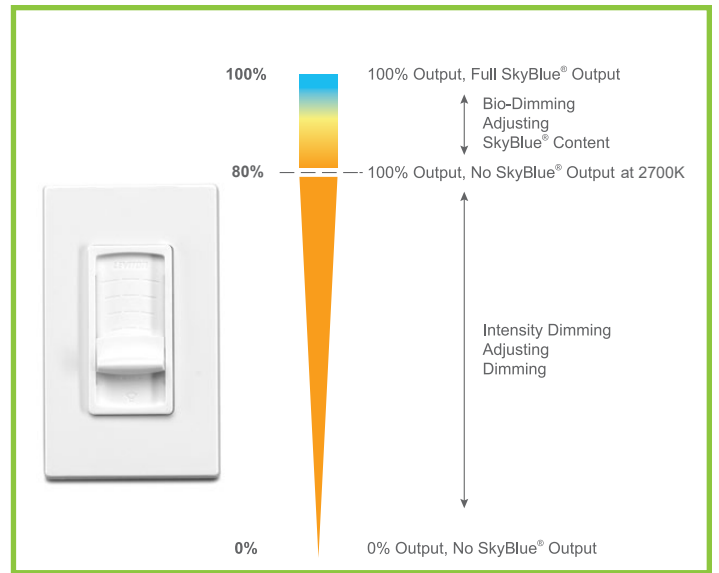

**Nominal Performance**

CCT		Melanopic Ratio (M/P) <sup>1</sup>		CRI	R9	COI <sup>2</sup>
Daytime	Night-time	Daytime	Nitght-time			
3000K	2700K	0.74	0.47	81	90	5.4
3500K	2700K	0.83	0.47	84	96	3.3
4000K	2700K	0.92	0.47	84	95	1.5

<sup>3</sup>CCT may vary by up to 500K

<sup>4</sup>Value as shown represents COI provided by daytime LED Spectrum.

Project:	Catalogue #:	Type:
Notes:		

**BIOS Dynamic Circadian LED Solution - V114 (BI03)**

BIOS SkyBlue® Dynamic Light Engine provides full daytime circadian stimulus and can be dynamically adjusted via tunable circadian LED module. Using a standard two channel 0-10V dimmer reducing melanopic lux and adjusting the output light level while keep CCT constant<sup>3</sup>. The SkyBlue® below 3000K no longer present. The tunable module also detects the preferred light levels over time and will adjust the high end trim of the system to those preferences.

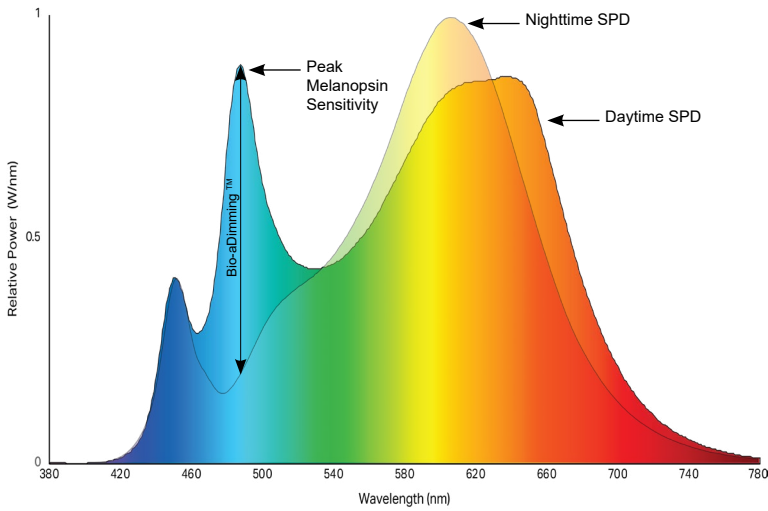

Dynamic Engine Spectral Power Distribution (3500K)

**BIOS Dynamic Tunable Circadian LED (tunable to 2700K)**

**Nominal Performance**

CCT		Melanopic Ratio (M/P) <sup>1</sup>		CRI	R9	COI <sup>2</sup>
Daytime	Night-time	Daytime	Nitght-time			
3000K	2700K	0.74	0.47	81	90	5.4
3500K	2700K	0.83	0.47	84	96	3.3
4000K	2700K	0.92	0.47	84	95	1.5

<sup>3</sup>CCT may vary by up to 500K

<sup>4</sup>Value as shown represents COI provided by daytime LED Spectrum.